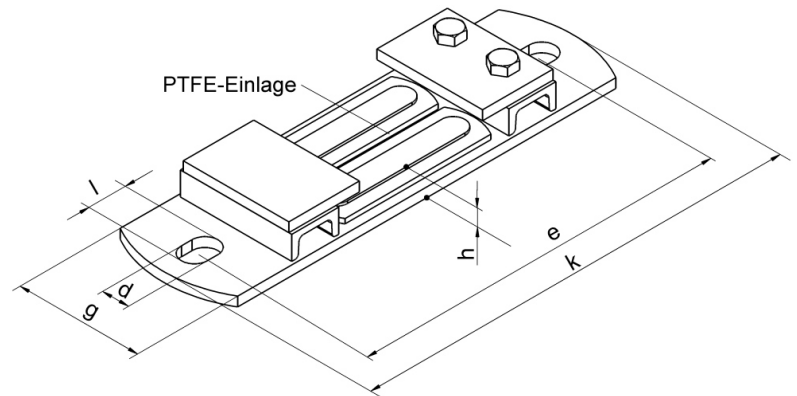
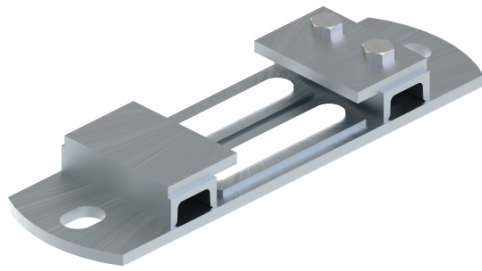

GLEITANSCHRAUBPLATTE Typ 302-121-U-SH

Abmessungen

dipa

**Auswahltable für Serie 121 U**

Alle Maße in mm

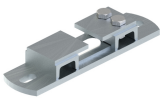
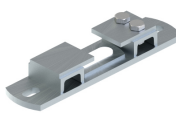
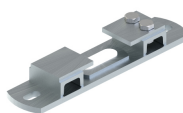
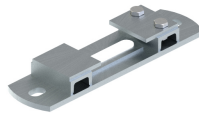
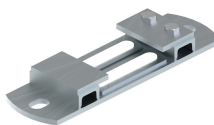
Rohr ø	Gr.	Artikelnummer feuerverzinkt	zul. Aufliege- last [kg]	e	g	k	l	d	h	Ausführung
26.9 - 88.9	1	25029323	800	190	60	235	26	13	14	
108.0 - 139.7	2	25029324	800	210	60	255	26	13	14	
168.3	3	25029325	800	230	60	275	26	13	14	
219.1 - 273.0	4	25029326	1500	257	80	309	26	18	14	
323.9 - 508.0	5	25029327	1800	287	100	349	31	22	14	

Lieferform

Werkstoff Nr.: 1.0038 in feuerverzinkt
Auch in Edelstahl Wst. Nr. 1.4301 und 1.4571 lieferbar.

**Kombinationsmöglichkeiten mit Typ**

121 U



Bestellangaben: Typ...
z.B. 302-121-U-SH

Größe...
Gr. 1

Oberfläche...
feuerverzinkt

Artikelnummer...
25029323

12.17